

DYMO®

LabelWriter® 550

LabelWriter® 550 Turbo

LabelWriter® 5XL

User Guide

newell
BRANDS

Copyright

© 2021 Newell Office Brands All rights reserved. Rev: 8/21

No part of this document or the software may be reproduced or transmitted in any form or by any means or translated into another language without the prior written consent of Newell Office Brands.

Trademarks

DYMO and LabelWriter are registered marks in the US and other countries. All other trademarks are the property of their respective holders.

Hereby, [NWL Belgium Services b.v.b.a.] declares that the radio equipment type [LabelWriter 550, LabelWriter 550 Turbo, LabelWriter 5XL] are in compliance with EU Directive 2014/53/EU and UK Radio Equipment Regulations SI 2017 No. 1206.

The full text of the EU and UK declarations of conformity are available at the following Internet address:

LabelWriter 550:

http://download.dymo.com\dymo\user-guides\LabelWriter\LW550Series\Declarations\LW550\LW550_CE_UK_Declaration_Conformity.en.pdf

LabelWriter 550 Turbo:

http://download.dymo.com\dymo\user-guides\LabelWriter\LW550Series\Declarations\LW550Turbo\LW550Turbo_CE_UK_Declaration_Conformity.en.pdf

LabelWriter 5XL:

http://download.dymo.com\dymo\user-guides\LabelWriter\LW550Series\Declarations\LW5XL\LW5XL_CE_UK_Declaration_Conformity.en.pdf

FCC Statement

Caution: The user is cautioned that changes or modifications not expressly approved by the party responsible for compliance could void the user's authority to operate the equipment.

Note: This equipment has been tested and found to comply with the limits for a Class B digital device, pursuant to part 15 of the FCC Rules. These limits are designed to provide reasonable protection against harmful interference in a residential installation. This equipment generates, uses and can radiate radio frequency energy and, if not installed and used in accordance with the instructions, may cause harmful interference to radio communications. However, there is no guarantee that interference will not occur in a particular installation. If this equipment does cause harmful interference to radio or television reception, which can be determined by turning the equipment off and on, the user is encouraged to try to correct the interference by one or more of the following measures:

- Reorient or relocate the receiving antenna.
- Increase the separation between the equipment and receiver.
- Connect the equipment into an outlet on a circuit different from that to which the receiver is connected.
- Consult the dealer or an experienced radio/TV technician for help.

IC Statement

This device contains licence-exempt transmitter(s)/receiver(s) that comply with Innovation, Science and Economic Development Canada's licence-exempt RSS(s). Operation is subject to the following two conditions:

- (1) This device may not cause interference.
- (2) This device must accept any interference, including interference that may cause undesired operation of the device.

This equipment complies with Industry Canada radiation exposure limits set forth for an uncontrolled environment.

Le présent appareil est conforme aux CNR d'Industrie Canada applicables aux appareils radio exempts de licence. L'exploitation est autorisée aux deux conditions suivantes : (1) l'appareil ne doit pas produire de brouillage, et (2) l'utilisateur de l'appareil doit accepter tout brouillage radioélectrique subi, même si le brouillage est susceptible d'en compromettre le fonctionnement.

Cet équipement est conforme à l'exposition aux rayonnements Industry Canada limites établies pour un environnement non contrôlé.

Contents

4 About Your New Label Printer

4 Registering Your Product

4 Getting to Know the Label Printer

6 Power

6 Label Feed buttons

7 Label Release Lever

7 Label Guide

7 About Labels

8 Designing and Printing Labels

8 System Requirements

9 Getting Started

9 Step 1. Installing the Software

9 Step 2. Connecting the Power

9 Step 3. Loading Labels

11 Step 4. Connecting the Printer to your Computer

11 Connecting the Printer Directly to your Computer

11 Connecting the Printer to a Local Area Network

12 Setting a Static IP Address

13 Caring for Your Printer

14 Safety Precautions

16 Getting Help

16 Power Status Light

16 Printer Issues

18 Performing a Printer Self-Test

19 Obtaining Customer Support

20 Technical and Environmental Information

20 Technical Specifications

21 Environmental Information

21 Device Certification

About Your New Label Printer

Congratulations on purchasing a DYMO LabelWriter® label printer. Your LabelWriter printer will give you years of reliable label printing. We encourage you to take a few minutes to review how to use and care for your printer.

This user guide provides information about the following LabelWriter models:

- LabelWriter® 550
- LabelWriter® 550 Turbo
- LabelWriter® 5XL

Visit www.dymo.com for information about obtaining labels and accessories for your label printer.

Registering Your Product

Visit www.dymo.com/register to register your label printer. During the registration process, you will need the serial number, which is located on the bottom of the label printer.

Register your label printer to receive these benefits:

- Email notification of free software upgrades
- Special offers and new product announcements

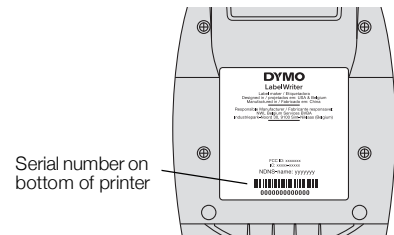

Getting to Know the Label Printer

Your LabelWriter printer is a direct thermal printer that does not use ink or toner. Instead, the printer uses heat from a thermal print head to print on specially treated, heat-sensitive labels. Labels are the only supplies you will ever need to buy.

Become familiar with the features shown in the following figures.

LabelWriter 550 and 550 Turbo

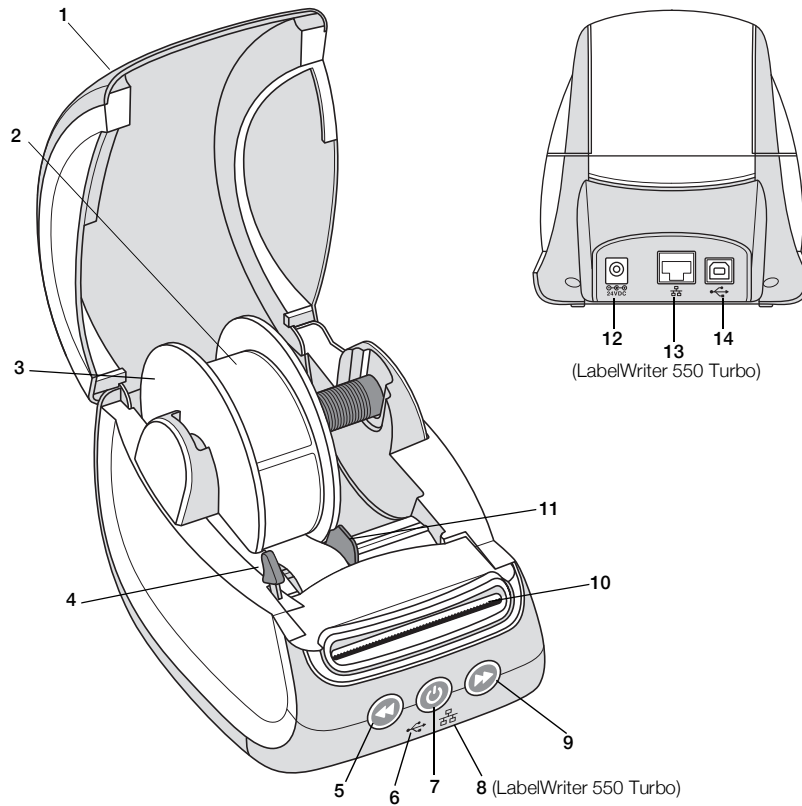

- | | | |
|------------------------------|--|---|
| 1 Cover | 6 USB status light | 11 Label guide |
| 2 Label roll | 7 Power (On/Off)
Printer status light | 12 Power port |
| 3 Label spool | 8 LAN status light
(LabelWriter 550 Turbo) | 13 LAN port
(LabelWriter 550 Turbo) |
| 4 Label release lever | 9 Label forward feed | 14 USB port |
| 5 Label reverse feed | 10 Label exit slot and tear bar | |

LabelWriter 5XL

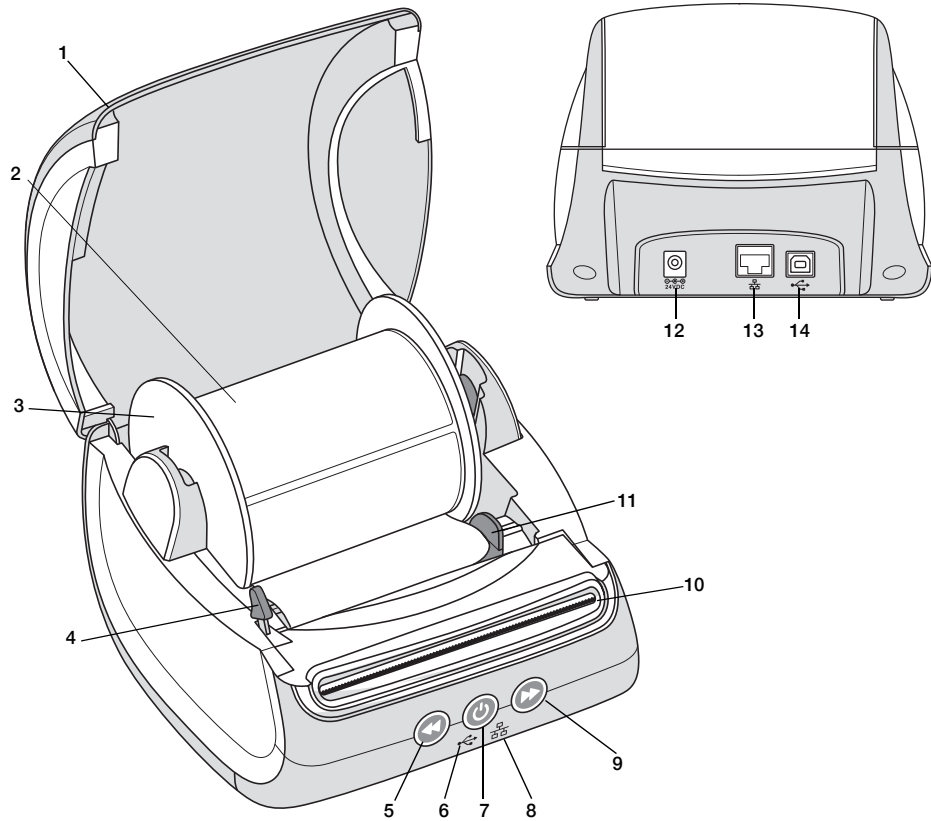

1	Cover	6	USB status light	11	Label guide
2	Label roll	7	Power (On/Off) Printer status light	12	Power port
3	Label spool	8	LAN status light	13	LAN port
4	Label release lever	9	Label forward feed	14	USB port
5	Label reverse feed	10	Label exit slot and tear bar		

Power

The  power button turns the label printer power on and off. After five minutes of inactivity, the printer will enter power-saving mode and the power status light will dim. While printing labels, pressing the power button will cancel printing.

Refer to **Power Status Light** on page 22 for more information.

Label Feed buttons

The  label forward feed button on the side of the printer advances a single label.

The  label reverse feed button reverses the label in the label exit slot out of the slot and is used to remove labels from the printer when changing rolls. Labels that have already passed through the label exit slot must be torn off first.

Label Release Lever

The label release lever releases the pressure of the print head from the labels so that the labels can be easily removed from the label exit slot.

Label Guide

The label guide is important for narrower labels such as address labels and other specialty labels. The label guide helps keep the labels aligned properly against the left edge of the label slot so the labels will feed properly.

About Labels

The LabelWriter 550 series of printers work only with Authentic DYMO LW Labels. Authentic DYMO LW labels support Automatic Label Recognition™, which allows DYMO software to receive information about the labels, such as which size label is in your printer and how many labels remain on the roll.

DYMO LabelWriter printers use advanced *direct thermal* printing technology to print on specially treated, heat-sensitive labels. This means you will never have to replace toner, ink cartridges, or a ribbon to print labels.



DYMO's warranty does not cover malfunction or damage that may be caused by the use of labels other than Authentic DYMO Labels. Because DYMO LabelWriter printers use direct thermal printing technology, you must use specially designed and manufactured labels. The thermal coatings used on labels other than Authentic DYMO Labels may not be compatible, and may provide unsatisfactory printing or cause the printer to malfunction.

How long your labels will last depends on how the labels are used. Thermal paper labels, such as those printed by the LabelWriter printer, are susceptible to fading in two ways:

- Exposure to direct sunlight, to fluorescent light for an extended period of time, or to extreme heat will cause fading.
- Contact with plasticizers (for example, labels placed on plastic ring binders) will cause fading.

In the original packaging, the shelf life for DYMO LW labels is 18 months. When labels are used for short-term applications (envelopes, packages, and so on), fading is not a problem. When labels are used to label files in a file cabinet, fading is very gradual over many years. Labels applied to the edge of a notebook that is then placed on a shelf in the sun will show signs of fading within a few months.

To prolong label life when labels are not in use, store the labels in a cool, dry place and in the black bag in which they were originally packaged.

Ordering Labels

DYMO offers a full range of labels for the LabelWriter printer, including labels suited for addressing envelopes, shipping packages, naming file folders, labeling all sorts of media, printing name badges, and much more. A complete listing can be found at the DYMO Web site: www.dymo.com.

 DYMO's warranty does not cover malfunction or damage that may be caused by the use of labels other than Authentic DYMO Labels. Because DYMO LabelWriter printers use thermal printing technology, you must use specially designed and manufactured labels. The thermal coatings used on labels other than DYMO-branded labels may not be compatible and may provide unsatisfactory printing or cause the printer to malfunction.

Designing and Printing Labels

Your label printer works with DYMO Connect for Desktop software to make designing and printing labels easy. You can also print labels directly from Microsoft Word with the DYMO Label Add-in. The Add-in is automatically installed when you install DYMO Connect for Desktop software, if Microsoft Word is installed on your computer.

System Requirements

The LabelWriter label printer requires one of the following:

- Windows® 8.1 or later
- macOS® Mojave v10.14 or later

Getting Started

Follow the instructions in this section to set up your label printer to print from your computer. To get started you will:

- 1 Download and install DYMO Connect for Desktop software.
- 2 Connect the power.
- 3 Load a label roll.
- 4 Connect the printer to your computer.



Step 1. Installing the Software



Do not connect the printer to your computer until after the software installation is complete.

DYMO Connect for Desktop software must be installed before connecting the printer to your computer. For LAN connections, the software must be installed on every computer that will print to the LabelWriter printer over the network.

- ▶ Download and install the latest version of DYMO Connect for Desktop software from support.dymo.com.



Step 2. Connecting the Power

The different LabelWriter printer models may have different power requirements.



Make sure to only use the power adapter that was included with your label printer. See **Technical Specifications** on page 29 for details.

To connect the power

- 1 Plug the power cord into the power adapter and plug the power adapter into the power connector on the back of the printer.
- 2 Plug the other end of the power cord into a power outlet.
- 3 Press  on the front of the printer to turn on the power.

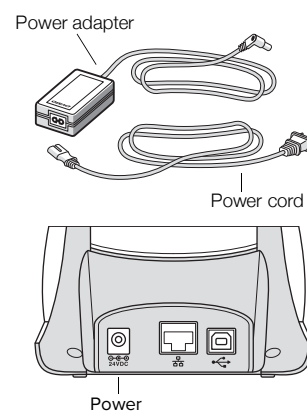

Step 3. Loading Labels

The LabelWriter 550 series of printers work only with Authentic DYMO LW labels. Non-authentic DYMO labels will not be recognized by the printers.

Each label roll comes in a black plastic bag. Make sure to store the label roll in this bag when the labels are not being used.

Important!

In order for the labels to feed properly during printing, pay attention to the following when loading labels onto the spool and into the printer:

- Make sure the power is turned on.
- The label spool guide must be pushed flush against the label roll, with no gap.
- The labels must be loaded with the left edge of the label inserted against the left edge of the label exit slot.

To load a label roll

- 1 Remove the label spool from inside the printer and separate the spool guide from the spindle.
- 2 Hold the spool spindle **(A)** in your left hand and place the label roll on the spindle so that the labels feed from underneath and the left edge of the label roll is firmly against the side of the spool.

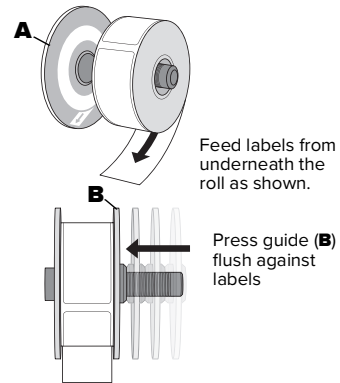



- 3 Slide the spool guide **(B)** onto the right side of the spool and press the guide tightly against the side of the label roll, **leaving no gap** between the roll and the spool.

To ensure proper feeding of labels during printing, the label roll must fit snugly against both sides of the label spool, with no gaps.

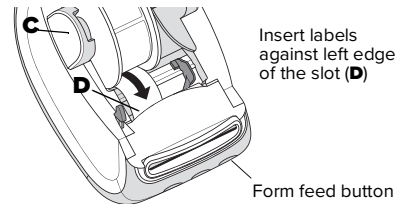
- 4 Insert the label spool into the slots **(C)** in the base of the printer with the labels extending from **underneath** the roll.
- 5 Align the left edge of the label with the left edge of the label exit slot **(D)** and insert the label into the slot.



- 6 Press the  form feed button to advance the label into position. If the first label on the roll is not a full label, press the  label forward feed button to eject the partial label.

Regardless of the label width, the left edge of the label must be aligned with the left edge of the label exit slot for the labels to feed properly.

- 7 Slide the label guide **(E)** to the left until the guide aligns with the right edge of the label.

Make sure that the label guide does not pinch the label.

- 8 Carefully lower the top cover.

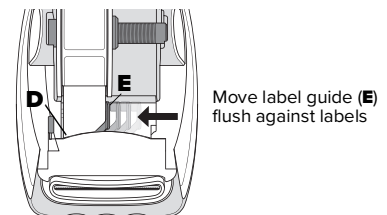

Step 4. Connecting the Printer to your Computer



All three printer models can connect to your computer with the USB cable supplied. The LabelWriter 550 Turbo and LabelWriter 5XL can also be connected to a local area network (LAN) with an Ethernet cable.

Connecting the Printer Directly to your Computer

You can connect the printer directly to your computer using a USB cable. Use only a DYMO USB cable with part number 1997364, available from Customer Support if you do not already have one.

STOP Do not connect the printer to your computer until after the software installation is complete.

To connect to the printer directly to your computer

- 1 At the end of the software installation, connect the printer to your computer.
 - a Plug the USB cable into the USB port on the back of the printer.
 - b Plug the other end of the cable into an available USB port on your computer.
- 2 Press  to turn on the power, if necessary.
The  USB status light on the front of the printer will be on.
- 3 Start DYMO Connect for Desktop software.

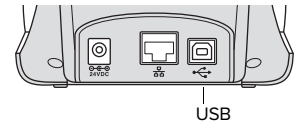



macOS: If the printer is not in the printer list when the installation is complete, refer to the macOS instructions on how to add it.



Connecting the Printer to a Local Area Network

The LabelWriter 550 Turbo and 5XL models can be connected to a local area network with a LAN cable (not included). All computers that will print over the network must have DYMO Connect for Desktop software installed.

To connect using a wired LAN

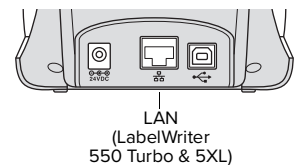
- 1 Plug the LAN cable into the LAN port on the back of the printer.
- 2 Plug the other end of the cable into an active LAN port on your network.
- 3 Press  to turn on the power, if necessary.
The  LAN status light on the front of the printer will be on.
- 4 Download and install DYMO Connect for Desktop on all computers that will print labels to this printer on the network.
- 5 In DYMO Connect for Desktop, select **Add Network Printer** from the **File** menu and follow the instructions to add the printer.



If the printer is connected to your computer both through USB and LAN ports, the printer will show up twice in DYMO Connect for Desktop: once with a  LAN icon and once with a  USB icon.

Setting a Static IP Address

By default, the printer will be assigned an IP address dynamically.

To assign a static IP address

- 1 Connect the printer through USB.
- 2 Open the **Printer Status** page for this printer in DYMO Connect for Desktop.
- 3 Select **Configure network**.
- 4 Set the **IP type** to **Static** and complete the required fields.

Caring for Your Printer

The LabelWriter printer is designed to give you long and trouble-free service, while requiring very little maintenance. You will get the best possible performance from your LabelWriter printer if you follow the setup instructions that appear in **Getting Started** on page 10, and the cleaning procedures described in this section.

To keep your LabelWriter printer working properly, you should clean it from time to time. Dusting the outside of the printer occasionally will help keep foreign matter from getting inside the printer. However, it is still a good idea to periodically perform some basic interior maintenance, such as cleaning the label path with a LabelWriter cleaning card (available from www.dymo.com).

You can easily clean your LabelWriter printer using the following items:

- Lint-free cloth.
- Diluted dishwashing detergent or diluted glass cleaner.
If you use glass cleaner, make sure it does not contain ammonia.
- Small, soft brush, such as a tooth brush or child's paint brush.
- LabelWriter cleaning card to clean the print head.
To purchase cleaning cards, visit www.dymo.com.

To clean the exterior of your printer and the label roll compartment

- 1 Remove the roll of labels.
- 2 Turn the power off and disconnect the power cord.
- 3 Use the lint-free cloth to wipe the exterior of the printer.
- 4 Remove dirt and smudges with one of the cleaning solutions mentioned above.
- 5 Lift the top cover.
- 6 Use a small, soft brush or cotton swab to whisk away paper dust and other stray particles from the inside of the printer.
- 7 Reconnect the power cord and turn on the printer.
- 8 If you have a LabelWriter cleaning card, follow the instructions printed on cleaning card packaging. If you do not have a cleaning card, contact DYMO Customer Support at www.dymo.com.
- 9 Reload the roll of labels and carefully close the top cover.

Safety Precautions

Read and understand all of the precautions listed below. Follow all warnings and instructions marked on the product.

General

- Dispose of plastic bags correctly and keep away from babies and children.
- Place the product on a flat, stable surface.
- Always use the product as instructed in this user guide.
- Unplug the power cord immediately if you notice any abnormal odor, heat, smoke, discoloration, deformation or anything unusual while using the product.
- Do not disassemble the product. For inspection, adjustment and repair of the product, contact DYMO Customer Support.
- Do not drop, hit, or otherwise mishandle the product.
- Do not allow any liquids to come into contact with the product.
- Make sure to turn off the power and remove the power cord from the electrical outlet before cleaning the product. Failure to do so could cause an electrical shock or fire.
- Do not insert foreign objects into the product.
- Do not use paint thinner, benzene, alcohol or any other organic solvents to clean the product. Doing so may cause damage to the surface finish. Use a soft, dry cloth to clean the product.

Power

- Use only the power cord and adapter that came with the product.
- Do not handle the power cord or adapter if your hands are wet.
- Do not cut, damage, alter, or place heavy objects on the power cord.
- Do not use the power cord or adapter if they are damaged.
- Do not pull the power cord when removing the plug from the electrical outlet. Doing so could cause an electrical shock or fire.
- Do not use the power adapter in a confined space or cover it with a cloth. Make sure there is sufficient ventilation to prevent the power adapter from overheating.
- If the product will not be used for an extended period of time, remove the power cord from the electrical outlet.

Printer

- Do not put fingers in moving parts or openings of the product.
- Do not block or insert objects into the label exit slot.
- Do not touch the tear bar. Personal injury could result.
- Do not place the product in areas exposed to direct sunlight, near heaters or other hot appliances, or in any area exposed to extremely high or low temperatures, high humidity, or excessive dust.
- Do not hold or lift the product by the cover.

Labels

- Use only Authentic DYMO labels. The product's warranty does not cover any malfunction or damage caused by the use of third-party labels.
- Apply labels only to a clean, dry surface at room temperature.
- Do not expose label rolls to direct sunlight, high temperatures, high humidity, or dust. Store in a cool, dark place.

Getting Help

Your LabelWriter printer should offer years of trouble-free printing with very little maintenance. However, in the event that you encounter a problem, this chapter offers suggestions for resolving problems that can occur when using the printer. If you are unable to solve a problem, this chapter also describes how to contact DYMO [Customer Support](#).

This section provides information on how to detect and correct problems you might encounter while using your LabelWriter printer.

- **Power Status Light**
- **Printer Issues**
- **Obtaining Customer Support**

Power Status Light

The power status light visually shows the current state of the printer:

Status Light	Description
Off	Power is off.
Solid on	Power is on and printer is ready.
Dim	Printer is in power saving mode.
Fast blinking	An error has occurred. This can occur because the labels are missing or due to some other error condition. Refer to some possible solutions later in this chapter.

Printer Issues

The following are solutions to some common issues you may encounter while working with the label printer.

Power Status Light Flashing

If the power status light is flashing, the problem could be one of the following:

Problem	Solution
No labels	The label roll is out of labels or there is no label roll inserted. LabelWriter 550 series printers work only with authentic DYMO LW labels. Any other labels will not be recognized.
Overheated print head	Turn the printer off and wait 3-5 minutes before turning the printer on again.
System error	Turn the printer off and then on again.

If the issues above don't correct the problem and the light is still flashing, contact Customer Support. See **Obtaining Customer Support** on page 19.

Printer is Not Showing Up in the Printer List

Make sure DYMO Connect for Desktop software is installed **BEFORE** connecting the printer.

For LAN connections, DYMO Connect for Desktop must be installed on each computer that will print to the LabelWriter printer.

For locations using both Ethernet and a wireless network, make sure the router is set to forward traffic between wired and wireless networks.

Correcting Poor Print Quality

Poor print quality is most frequently caused by one of the following:

- An old roll of labels
- Labels where the thermal coating has been compromised
- A dirty print head

If the print quality becomes faint, small dots of white appear scattered through the printed characters, or light and dark patches of printing appear, you are probably using a faulty roll of labels. Try using a different roll from a fresh box. If the second roll prints correctly, the problem is with the first roll of labels.

Another possibility is that the LabelWriter print head needs cleaning. See **Caring for Your Printer** on page 13 for information about cleaning the label path with a LabelWriter cleaning card.

Labels Do Not Feed Correctly

If your labels do not feed correctly, check the following, make sure your labels are loaded properly.

- The spindle guide must be pressed firmly against the right edge of the labels to keep them from sliding.
- The label roll must be placed on the spindle with the labels coming from underneath the roll.
- The left edge of the label must be aligned with the left edge of the label exit slot and the label guide should be aligned with the right edge of the label.

See **Step 3. Loading Labels** on page 9.

Clearing Label Jams

Normally, pressing the  reverse feed button will reverse the labels out of the label slot. But if the labels become jammed or stuck to the roller, then follow these instructions.

To clear labels that have become jammed in the printer

- 1 Tear off any labels that have already fed through the printer.
- 2 Press the label release lever forward and gently pull the jammed label out of the label exit slot.

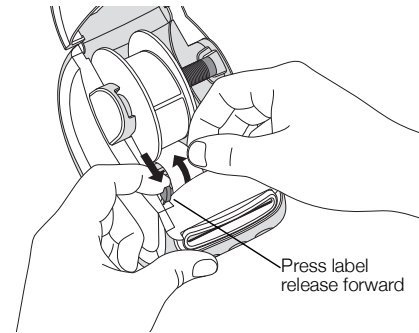

Printer Does Not Print or Stops Printing

If your printer does not print or stops printing while in use, follow the steps below to track down the problem.

- 1 Make sure the printer is still getting power and that the power cable has not been disconnected.

If the power status light on the front of the printer is not on, check to make sure the power cable is plugged in. If using a power strip, make sure it is working.

To make sure the problem is not with the outlet or power strip, try plugging something else into the wall outlet and power strip.

Make sure you are using the power adapter and cable that came with your printer. LabelWriter printer models have different power requirements, so power adapters from other models may not be compatible with your printer.

- 2 Confirm that the printer is feeding labels properly by pushing the  label forward feed button while the printer is on.

If the labels are jammed, the power status light will blink. Refer to **Correcting Poor Print Quality** on page 17.

- 3 Make sure that your USB cable has not come loose from the back of your printer or from your computer.

Refer to the installation instructions in **Step 4. Connecting the Printer to your Computer** on page 11 to make sure the cable is connected properly.



- 4 (Windows) Check that your LabelWriter printer driver is installed correctly.

The LabelWriter printer driver takes print data from your software and directs it to the LabelWriter printer. The driver is automatically installed when you install the DYMO Connect for Desktop software. However, the driver may have been changed or deleted by mistake.

Performing a Printer Self-Test

If you experience problems with broken characters or other print quality issues, perform a printer self-test. The self-test verifies that all elements of the print head and printing mechanism are in working condition.

To perform a self-test

- 1 With a roll of labels in the printer, press and hold the  button and the  label forward feed button for at least ten seconds.

The printer begins printing a test pattern along the width of the printer.

- 2 Once the self-test begins, release both buttons.
- 3 To stop the self-test, press and release the  power button.

If you are still having problems after checking the above items, contact Customer Support. See **Obtaining Customer Support** on page 19.

Obtaining Customer Support

If you experience problems with the setup or use of your printer, carefully read this user guide to make sure you have not missed something that is covered in the documentation.

If you cannot resolve your problem by consulting the documentation, you can obtain additional information and assistance from DYMO.









DYMO maintains an Internet Web site at www.dymo.com that includes the latest support information for your LabelWriter printer.

To contact us, visit the Support area of our Web site at: support.dymo.com

Technical and Environmental Information

This chapter contains technical and certification information for the LabelWriter printers.

Technical Specifications

	LabelWriter 550	LabelWriter 550 Turbo	LabelWriter 5XL
Print Method	Direct Thermal		
Print Resolution	300 dpi		
Maximum Print Width	2.25 in (56 mm)		4.16 in (105.73 mm)
Maximum Media Width	2.44 in (62 mm)		4.53 in (115 mm)
USB Interface	USB 2.0 Full speed Printer Class Device		
USB Connector Type	USB 2.0 – Type B		
LAN Connector Type	N/A	RJ45; 10/100 Ethernet MAC, IPv4	
Dimensions (WHD)	5 in (127 mm) x 5.35 in (136 mm) x 7.36 in (187 mm)		7.09 in (180 mm) x 5.35 in (136 mm) x 7.36 in (187 mm)
Weight (printer and spool only)	1.41 pounds (640 g)	1.42 pounds (645 g)	1.95 pounds (885 g)
Printer Power Requirements	24.0V  1.75A	24.0V  2.5A	24.0V  3.75A
Power Adapter Model	DSA-42PFC-24 2 240175 from Dee Van Enterprise Co., Ltd.	DYS865-240250W from Dongguan Dongsong Electronic Co., Ltd.	DSA-96PFB-24 2 240375 from Dee Van Enterprise Co., Ltd.
Adapter Power Rating	100-240VAC 50/60Hz 1.2A 24.0V  1.75A  , 42.0W	100-240VAC 50/60Hz 1.5A MAX 24.0V  2.5A  , 60.0W	100-240VAC 50/60Hz 1.5A 24.0V  3.75A  , 90.0W
Operating Range	20°C to 25°C, 50% to 70% relative humidity (Optimum print quality in an office setting) 4°C to 40°C, 20% to 95% relative humidity (Maximum operating range)		
Operating Frequency	13.56MHz		
RF Output Power	<42dBµA/m at 10m		
Storage Range	Between -18° to 60°C and once returned to room temperature (after 4 hours), operate in a normal fashion		
Regulatory Approvals	CE/GS/RoHS/REACH/FCC ID/IC/RCM, etc. For regulatory approvals for specified countries, contact the local team for details.		
Warranty	Two Year Limited		

Environmental Information

The equipment that you have bought requires the extraction and use of natural resources for its production. It may contain substances that are hazardous to health and the environment.

In order to avoid the dissemination of those substances in our environment, and to diminish the pressure on natural resources, we encourage you to use the appropriate take-back systems. These systems will reuse or recycle most of the materials of your end-of-life equipment in an environmentally sound way.

The crossed-bin symbol marked on your device indicates you should use these systems.



If you need more information on the collection, reuse, and recycling of this product, please contact your local or regional waste administration.

You can also contact DYMO for more information on the environmental performance of our products.

Device Certification

This device has been tested and complies with the requirements of:

- CB Certificate

- GS Certificate

- CE Mark

- FCC Part 15

- ICES-003, RSS-210 and RSS-Gen

- RCM

- RoHS directive 2011/65/EU (RoHS2) and Annex II (EU) 2015/863

This device is not intended for use in the direct field of view at visual display workplaces. To avoid incommoding reflections at visual display workplaces, this device must not be placed in the direct field of view.